

OPTURA[®] PALM[®]

Total biomass readings in
the palm of your hand

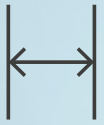

ABER



Contactless
measurement



Reduces risk of
contamination



Quick readings





OPTURA[®] PALM[®]

Designed with convenience in mind, the **OPTURA PALM** sensor is the perfect companion for the lab.

This handheld device provides on-the-spot total biomass readings. Designed with user-friendliness in mind, simply press the sensor against your shake flask or vessel, and receive your measurement within seconds.

The contactless nature of the **OPTURA PALM** significantly reduces the risk of contamination, eliminating the need to open flasks for manual cell counts. Increase your workflow efficiency and productivity by swiftly moving on to the next task.

The PALM works together with the PALM Connect software which is used to upload, store, and manage readings. Create custom biomass calibrations and upload them to the device for future use, allowing the device to read out in a familiar unit.



Can be used on a variety of vessel types

Compatible with various vessel types and materials, from shake flasks to Falcon tubes, the OPTURA PALM can be used with a wide range of cell types, making it an indispensable tool in any lab.

Key benefits:

- Contactless
- Reduce risk of contamination
- Readings in 5 seconds
- Portable
- Customisable read out
- Upload up to 16 custom Biomass calibrations



How OPTURA works

The **OPTURA** PALM is part of the **OPTURA** range, which utilises near Infrared bio-reflectance for total cell density readings. **OPTURA** utilises an NIR laser which is emitted from the sensor face into the media, cells present in the media reflect the laser back into the sensor's measurement face, resulting in a measurement of reflectance where increasing reflectance return corresponds with increasing biomass.

Fixed NIR wavelength

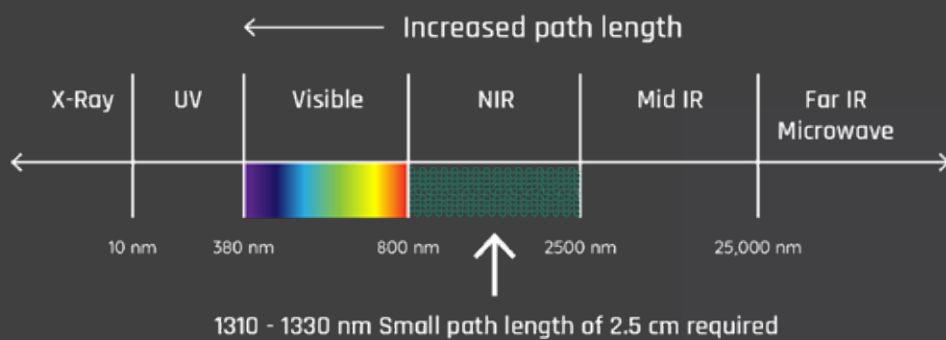

OPTURA's fixed 1310-1330 nm wavelength enables high sensitivity to biomass from seeding to harvest. This wavelength eliminates signal loss due to absorbance and performs well with coloured media, while offering a narrow 2.5 cm measurement penetration depth. This allows the sensor's use in restricted environments, reducing interference and back reflectance.

Together, the **OPTURA** range can tackle a wide variety of applications from real time monitoring of biomass in bioreactors to on the spot, handheld biomass readings in shake flasks.

Bio-reflectance technology effortlessly accommodates a variety of cell types, including mammalian and microbial cells. By harnessing superior reflectance technology, the sensor achieves a linear biomass range, all within a single sensor. This eliminates the need for frequent wavelength switching or adjustment of settings, providing a simplified and efficient monitoring experience.

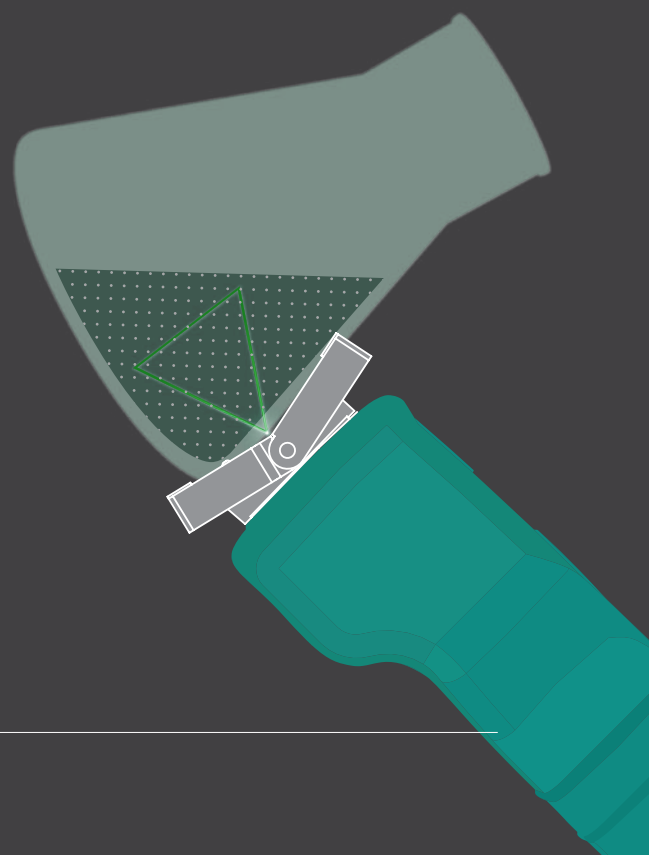



The following data examples demonstrate a linear relationship between different cell types and the raw reflectance output from the OPTURA PALM, measured in NanoWatts (nW).

The OPTURA PALM can be calibrated to read out in a more familiar measurement, for example: g/L, CPM or OD600. This can be achieved by creating a biomass calibration by simply taking readings across your concentration range and creating the calibration in the PALM Connect software.

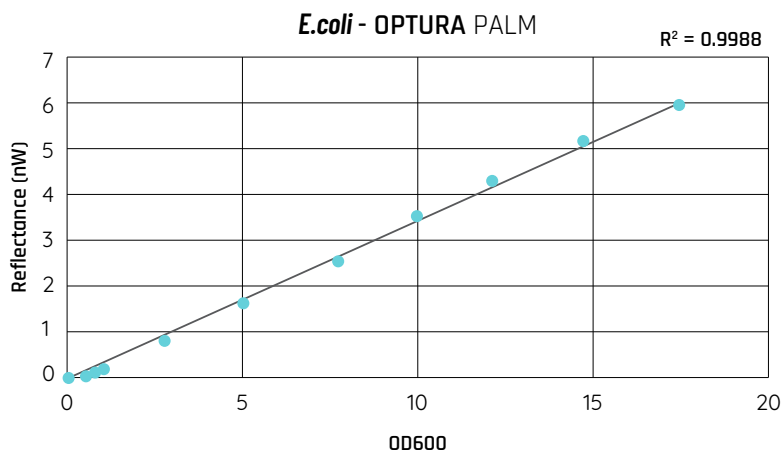

E. coli in LB media, measured in a 250ml Erlenmeyer shake flask.

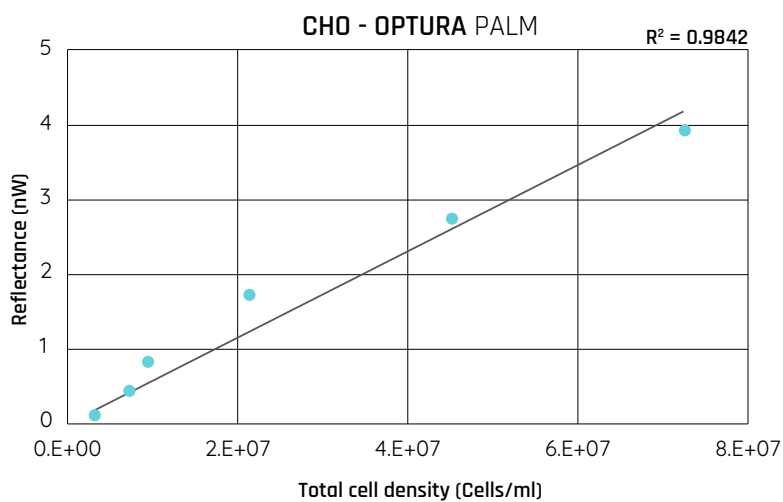

CHO cells in CHO-S-Freestyle media, measured in a 125ml PETG shake flask.

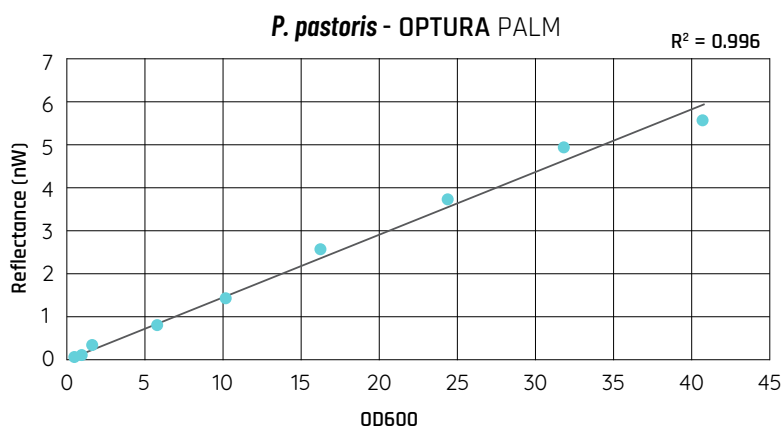

Pichia pastoris in YPD media, measured in a 250ml Erlenmeyer shake flask.

OPTURA® PALM®

Product specification

8530-00 OPTURA PALM

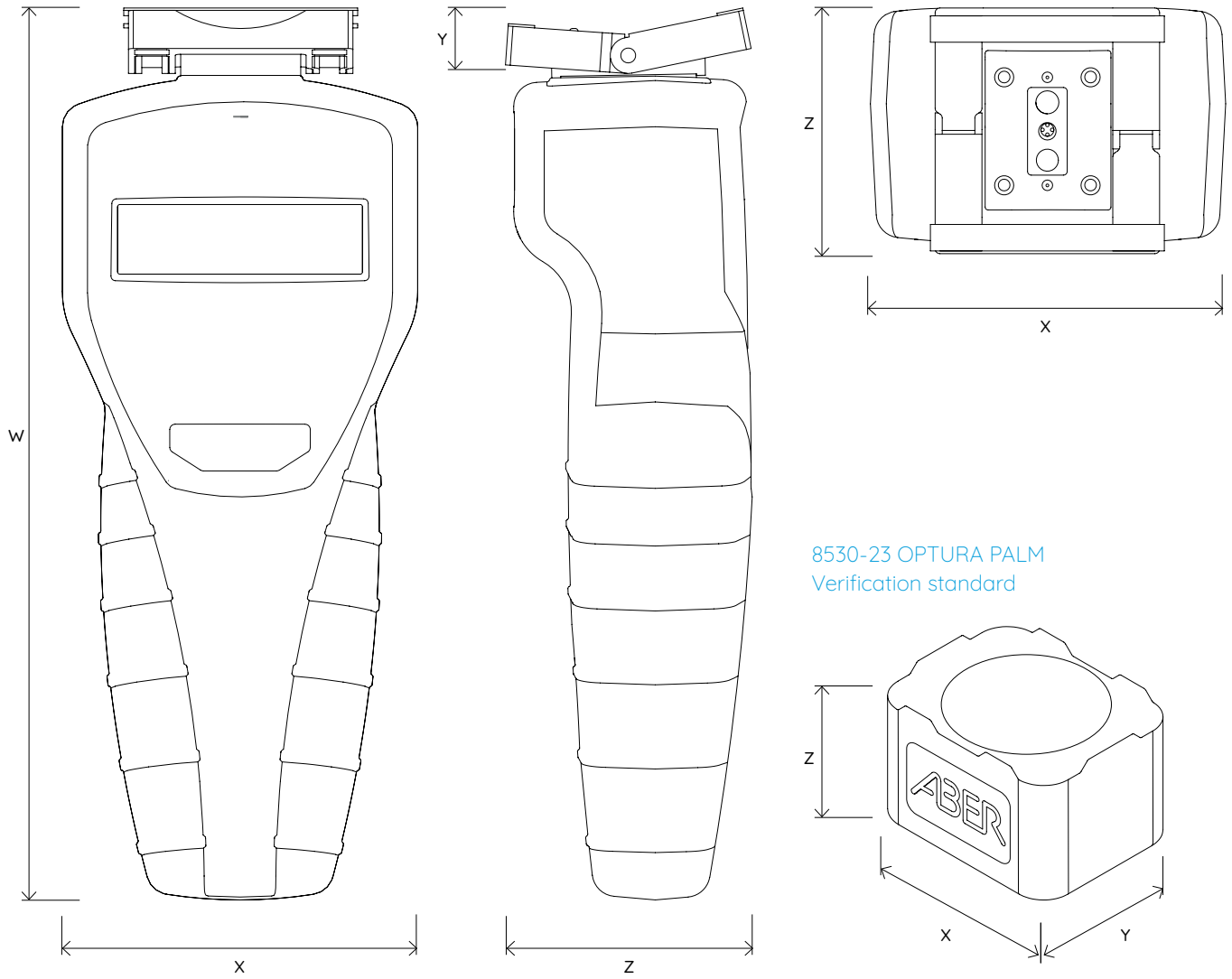

Part Number	Description	Dimensions (mm)			
		W	X	Y	Z
8530-00	OPTURA PALM	19	74	22	50
8530-23	OPTURA PALM Verification standard	-	34	26.75	22.3



PALM instrument display

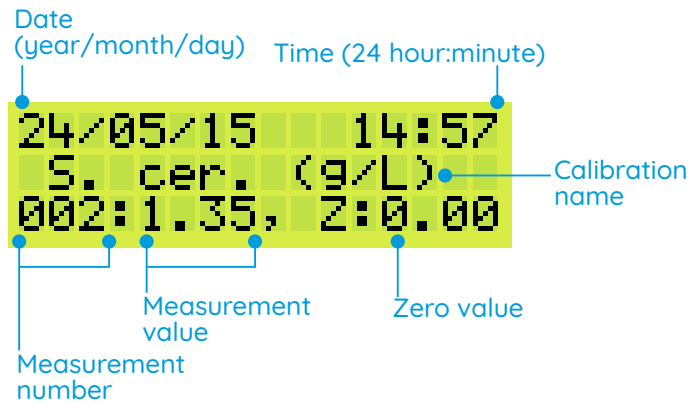

Parameter	Result
Wavelength	1310 nm
Cell Concentration Range	E. coli: 0.5 - 15.5 (OD600) S. cer: 3.5×10^6 - 8×10^7 cells/ml 0.3 - 6 g/l CHO: 3×10^6 - 1.9×10^8 cells/ml
Accuracy:	+/- 0.2nW or +/-15% system accuracy
Power Supply	Portable rechargeable device Charged via USB port on PC/laptop or wall plug adapter Low self-discharging NiMH batteries
Ambient operating conditions	5 to 35°C (41 to 95°F)
Vessel Wall Thickness	>4 mm (Full measurement range up to 4mm, reduced range up to 12mm)
Performance verification	Solid Verification standard
Laser product classification	Class 1M
Maximum measurement time	7 seconds
Connectivity (data transfer)	USB
Measurement memory	1000 readings

At ABER, our customer-centric approach is at the core of everything we do. We take pride in fostering collaborative partnerships to deliver the best possible solutions. Our dedicated sales and support team, along with our extensive distributor network, ensures world-class support for our valued customers.

Sales enquiries & orders

Feel free to get in touch with our sales team today, and let us demonstrate how ABER can elevate your biomass monitoring capabilities to new heights.

sales@aberinstruments.com

+44 (0)1970 636 300

Technical support

We understand the importance of having access to reliable technical assistance, and our knowledgeable team is committed to sharing their expertise to address any inquiries you may have. Whether you require clarification on product specifications, troubleshooting assistance, or guidance on optimising performance, we are here to help.

support@aberinstruments.com

+44 (0) 1970 636 300

Distributor network

At ABER, we have established a global network of hand-picked distributors who have undergone rigorous training to provide exceptional service and support. To locate your nearest distributor, visit our website and navigate to the distributor section.

www.aberinstruments.com/find-a-distributor

For more information regarding ABER Instruments' OPTURA product suite and applications please contact:

Lindsey Male

Product Manager, ABER Instruments Ltd.

Email: **lindsey@aberinstruments.com**

Phone: **+44 7483 044 849**

Or visit our website: **www.aberinstruments.com**

The ABER logo is rendered in a bold, teal-colored, sans-serif font. The letters are closely spaced, and the overall style is modern and professional.